

75mm OSCILLOSCOPE
MODEL: GOS-310

82OS-31000MA

TABLE OF CONTENTS

EC DECLARATION OF CONFORMITY	3
FOR UNITED KINGDOM ONLY	4
I.FEATURES AND SAFETY TERMS	5
II.SPECIFICATIONS	7
III.PANEL CONTROLS AND FUNCTIONS	10
IV. GENERAL EQUIPMENT SAFETY	12
V.SPECIAL SAFETY NOTES ABOUT YOUR OSCILLOSCOPE	12
VI. PRECAUTIONS TO PROTECT YOUR OSCILLOSCOPE	13
VII. GENERAL OPERATION	14
1. INITIAL SET-UP	14
2. USING DIFFERENT TRIGGERING MODES	14
VIII. APPLICATIONS	16
1. DC VOLTAGE MEASUREMENT	16
2. PEAK-TO-PEAK VOLTAGE MEASUREMENTS	17
3. PEAK-TO-PEAK VOLTAGE MEASUREMENTS (OUT OF RANGE)	18
4. WAVEFORM PERIOD MEASUREMENTS	18
5. OUT-OF-RANGE PERIOD MEASUREMENTS	20
6. PHASE DIFFERENCE MEASUREMENT (POINT-SHIFT METHOD)	20
7. COMPARATIVE FREQUENCY MEASUREMENTS AND PHASE COMPARISONS	21
IX. GENERAL ADJUSTMENTS AND CHECKS	24
1. PROBE COMPENSATION	24
2. HORIZONTAL TRACE ALIGNMENT WITH GRATICULE	24
3. QUICK CALIBRATION CHECK	24
4. CASE REMOVAL	25
5. FUSE REPLACEMENT	25
6. CHANGING VOLTAGE OF OPERATION	26
7. POWER SUPPLY VOLTAGE CHECKS	26
8. ASTIGMATISM ADJUSTMENT	27

9. CLEANING	27
X. VERTICAL CIRCUITS ADJUSTMENTS.....	27
1. DC BALANCE ADJUSTMENT	27
2. HIGH FREQUENCY COMPENSATION	27
3. VERTICAL GAIN CALIBRATION	28
4. VERTICAL POSITION CENTERING	28
5. VERTICAL FREQUENCY COMPENSATION.....	28
XI. HORIZONTAL CIRCUIT ADJUSTMENTS	29
1. HORIZONTAL VARIABLE RANGE ADJUSTMENT	29
2. TIME BASE CALIBRATION	29
3. HORIZONTAL POSITION ADJUSTMENT	29
4. EXTERNAL HORIZONTAL EXT SENSITIVITY AND POSITION ADJUSTMENTS	30
5. TRIGGERING STABILITY ADJUSTMENT	30
XII. CALIBRATE SIGNAL ADJUSTMENT	31
1. CALIBRATE SIGNAL FREQUENCY ADJUSTMENT	31
2. CALIBRATE SIGNAL VOLTAGE ADJUSTMENT	31
XIII. SCHEMATICS.....	32

EC Declaration of Conformity

We

GOOD WILL INSTRUMENT CO.,LTD.

(1) NO. 18, Lane 54, Chung Cheng Rd., Hsin-Tien City, Taipei Hsien, Taiwan, R.O.C.

(2) Plot 522, Lorong Perusahaan Baru 3, Prai Industrial Estate, 13600 Prai, Penang, Malaysia

declare under sole responsibility that the **GOS-310**

meets the intent of Directive 89/336/EEC ; 92/31/EEC ; 93/68/EEC for Electromagnetic Compatibility

Compliance was demonstrated to the following specifications as listed in the industrial Technology

Research institute :

EN50081-1: Electromagnetic compatibility - (1992) Generic emission standard Part I: Residential, commercial and light industry			EN50082-1: Electromagnetic compatibility - (1992) Generic immunity standard Part I: Residential, commercial and light industry		
Conducted Emission	EN 55022	class B	Electrostatic Discharge	IEC 1000-4-2	(1995)
Radiated Emission		(1994)	Radiated Immunity	IEC 1000-4-3	(1995)
Current Harmonics	EN 61000-3-2	(1995)	Electrical Fast Transients	IEC 1000-4-4	(1995)
Voltage Fluctuations	EN 61000-3-3	(1987)	Surge Immunity	IEC 1000-4-5	(1995)
Low Voltage Directive	EN 61010-1	(1993)	Voltage Dip/Interruption	EN 61000-4-11	(1994)

FOR UNITED KINGDOM ONLY

NOTE

**This lead/appliance must only
be wired by competent persons**

WARNING

THIS APPLIANCE MUST BE EARTHED

IMPORTANT

**The wires in this lead are coloured in
accordance with the following code:**

Green/

Yellow: Earth

Blue: Neutral

Brown: Live(Phase)

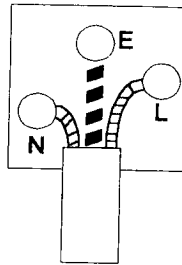

As the colours of the wires in main leads may not correspond with the colours markings identified in your plug/appliance, proceed as follows:

The wire which is coloured Green & Yellow must be connected to the Earth terminal marked with the letter E or by the earth symbol ⊕ or coloured Green or Green & Yellow.

The wire which is coloured Blue must be connected to the terminal which is marked with the letter N or coloured Blue or Black.

The wire which is coloured Brown must be connected to the terminal marked with the letter L or P or coloured Brown or Red.

If in doubt, consult the instructions provided with the equipment or contact the supplier.

This cable/appliance should be protected by a suitably rated and approved HBC mains fuse; refer to the rating information on the equipment and/or user instructions for details. As a guide, cable of 0.75mm^2 should be protected by a 3A or 5A fuse. Large conductors would normally require 13A types, depending on the connection method used.

Any moulded mains connector that requires removal /replacement must be destroyed by removal of any fuse & fuse carrier and disposed of immediately, as a plug with bared wires is hazardous if engaged in a live socket. Any re-wiring must be carried out in accordance with the information detailed on this label.

I. FEATURES AND SAFETY TERMS

The oscilloscope is a general-purpose oscilloscope with features to make it a useful, versatile piece of test equipment offering waveform, frequency, and voltage analysis of frequencies up to 10MHz.

The vertical deflection system offers 4 calibrated ranges from 5mV to 5V/div in decade sequence. The vertical variable control allows continuously variable vertical deflection capability. The input signal may either be capacitively or directly coupled by use of the AC - DC switch.

The horizontal amplifier features 6 calibrated sweep rates from 0.1 μ s to 10ms/div with a sweep variable control to allow continuous sweep rate variation. The sweep may be internally triggered from the vertical signal or may be externally triggered by a separate input signal. A free-running AUTO mode is provided for sweep without the presence of a triggering signal. A TV triggering mode is offered to aid in stable internal triggering on some television signals.

The horizontal deflection may also be used with an external input to allow frequency and phase comparison between two signals.

The oscilloscope features a short length 75mm round CRT that allows the scope to be small and lightweight for easy use and minimum space requirement. The screen is covered with a graticule marked 10 units wide and 8 units high for convenience and accurate measurements.

A 1kHz 0.25v square wave is also available on the front panel to allow a quick calibration check of the vertical and horizontal amplifiers as well as probe compensation adjustment.

These terms may appear in this manual:



WARNING. Warning statements identify conditions or practices that could result in injury or loss of life.



CAUTION. Caution statements identify conditions or practices that could result in damage to this product or other property.

These terms may appear on the product:

DANGER indicates an injury hazard immediately accessible as you read marking.

WARNING indicates an injury hazard not immediately accessible as you read marking.

CAUTION indicates a hazard to property including the product.

The following symbols may appear on the product:



DANGER
High Voltage



ATTENTION
Refer to Manual



Protective Ground
(Earth) Terminal



Frame or Chassis
Terminal

II.SPECIFICATIONS

VERTICAL SYSTEM

Characteristic	Specification	Remarks
Sensitivity	5mV/div to 5V/div	4 calibrated decade steps
Frequency bandwidth	AC : 2Hz to 10MHz, DC : DC to 10MHz	within -3dB
Input impedance	1 Megohm \pm 5% less than 35pF	
Accuracy	within 3%	
Max. input Voltage	600Vp-p or 300Vpk(DC+AC peak)less than 1 min	AC: less than 1 kHz

HORIZONTAL SYSTEM

Characteristic	Specification	Remarks
Sweep Rate	10ms/div to 0.1us/div	6 calibrated decade steps
Accuracy	within 5%	

AMPLITUDE CALIBRATOR

Characteristic	Specification	Remarks
Output Voltage	0.25Vp-p square wave \pm 3%	
Repetition Rate	1kHz \pm 5%	

X-Y OPERATION

Characteristic	Specification	Remarks
Sensitivity	0.1V/div	
Frequency bandwidth	DC to 500kHz	within -3dB
Input Impedance	1 Megohm \pm 5% less than 35pF	
Max. Input Voltage	600Vp-p or 300Vpk(DC+AC peak)	
phase difference	3° or less at 10kHz	

CATHODE RAY TUBE

Characteristic	Specification	Remarks
Display Area	75mm round screen	
Graticule	8div × 10div	6mm/div
Accelerating Potential	1.2 kV	

TRIGGERING

Characteristic	Specification	Remarks
Mode	AUTO, NORM, EXT, TV	
Source	INT, EXT	
Sensitivity	INT: 30Hz to 2MHz 0.5div, 2MHz to 10MHz 1.5div EXT: 30Hz to 2MHz 0.5V _{p-p} , 2MHz to 10MHz 1V _{p-p}	
Max. Input Voltage	600V _{p-p} or 300V(DC+AC peak)	
Input impedance	1 Megohm ± 5% less than 35pF	

POWER SOURCE

Characteristic	Specification	Remarks
Line Voltage	AC 115V/220V/230V	
Line Frequency	50Hz to 60Hz	
Power Consumption	approximately 30W	

DIMENSIONS AND WEIGHT

Characteristic	Specification	Remarks
Dimensions	132mm Wide × 210mm High × 298mm Long	
Weight	approximately 4.6kg	

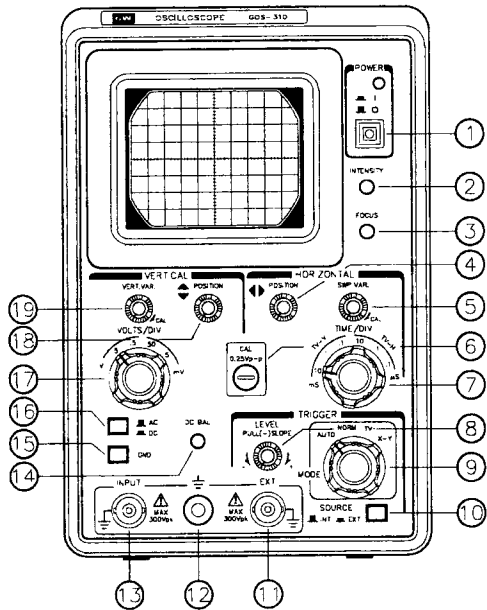

Fig. 1. Front Panel

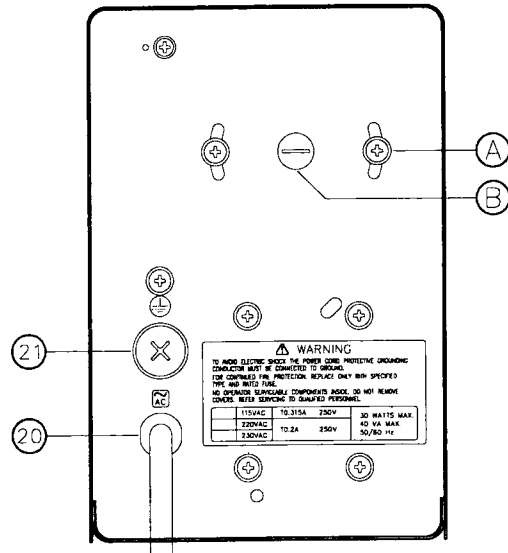

Fig. 2. Rear Panel

III.PANEL CONTROLS AND FUNCTIONS

(see Fig. 1 and 2)

1	POWER	Turns oscilloscope on when in the ON position.
2	INTENSITY	Used to adjust the brightness of the display. The display becomes brighter when the knob is rotated clockwise.
3	FOCUS	Adjusts the focus of the trace or spot.
4	←→ POSITION	This will move the display left or right.
5	SWP. VAR.	Varies the sweep rates to values between the settings of the TIME/DIV selector. Sweep rates are calibrated when this control is rotated fully clockwise.
6	CAL 0.25Vp-p	Provides a square wave signal of approximately 0.25Vp-p at 1kHz for frequency compensation of the input probe and frequency calibration check.
7	TIME/DIV	Selects calibrated horizontal sweep rates from 0.1us/div to 10ms/div in 6 decade ranges when the SWP.VAR. control is in the CAL position.
8	LEVEL	<p>Rotation performs trigger LEVEL adjustment and pushpull action changes SLOPE of triggering + or - .</p> <p>LEVEL: Rotation of this control adjusts the voltage level of the input signal on which triggering takes place. CCW rotation (-) cause a more negative voltage point triggering and CW (+) rotation causes a more positive voltage point triggering.</p> <p>SLOPE: The sweep is triggered on the positive-going slope of the triggering waveform when the switch is pushed in and on the negative-going slope of the triggering waveform when the switch is pulled out (PULL, SLOPE(-)).</p>
9	TRIGGER MODE	<p>Selects the operating mode for the trigger circuit.</p> <p>AUTO: Automatically provides sweep triggering in the absence of an input signal (free run). provides triggered sweep operation to some degree when an input signal is present.</p> <p>NORM: The sweep will not start without an input trigger signal. This is the normal triggered sweep mode.</p> <p>TV: The input signal is filtered before being fed to the triggering circuits to provide more stable triggering on some television video signals.</p> <p>X-Y: This position of the switch disconnects the sweep circuits and allows a signal to be applied to the horizontal circuits from the EXT INPUT jack.</p>

10	SOURCE	Selects the source of the trigger signal. INT: The trigger signal is derived from the displayed waveform. EXT: The trigger signal is derived from a separate signal applied to the EXT.INPUT jack.
11	EXT	Input jack for external horizontal input or external trigger.
12	GND	Ground terminal.
13	INPUT	This is where vertical input signal are applied.
14	DC BAL	This control should be so adjusted that the baseline of trace is not vertically shifted when VERT.VAR nobe is turned.
15	GND SWITCH	Connects the input to the vertical amplifier to ground for an interference-free reference display. In this position the vertical input jack is disconnected.
16	AC-DC	Selects the input coupling mode. AC: Vertical input is capacitively coupled so that the DC component is blocked. DC: The input signal is directly coupled to the vertical amplifier.
17	VOLTS/DIV	This varies the vertical deflection height of an input voltage. It provides 4 decade ranges from 5mV/div to 5V/div when the VERT. VAR. control is in the CAL position.
18	↑↓ POSITION	Allows movement of the display up or down.
19	VERT. VAR.	This varies the vertical deflection height between the settings of the VOLTS/DIV selector. The vertical deflection is calibrated when this control is in the fully clockwise CAL position.
20	CORD	Non detachable power supply cord.
21	FUSE	The fuse inside the fuse holder. 250V/0.315A(Time lag) is used for a normal 115V supply line voltage. 250V/0.2A(Time lag) is used for a normal 220V or 230V supply line voltage.
B	ROTATION	Time base rotation adjustment.

ACCESSORIES

Operation Manual..... 1
Test Lead..... 1

IV. GENERAL EQUIPMENT SAFETY

Following the safety rules below will significantly reduce the possibility of fatal shock.

1. Don't expose yourself to high voltages unnecessarily. Remove protective housings and covers only as necessary. Don't make test connections when the circuit is energized. Discharge high-voltage capacitors after equipment is de-energized.
2. Try to use only one hand when making adjustments on live circuits. Avoid inadvertent contact with any parts of the equipment because certain faults may cause high voltages to be present at unexpected locations.
3. Work in an area with dry insulative floor material if possible or use a large mat of insulating material to stand on or put under your chair and feet. If equipment is moveable, place it on an insulated surface while servicing it.
4. When using a probe, touch only the insulated portion.
5. Know the circuits you are working on and avoid areas of especially high voltages. Remember that line voltages may be present in some places even with the equipment turned off.
6. Metal parts of equipment with two-wire AC power cords, even with polarized plugs, may not be at ground potential. This not only presents a shock hazard but also may cause test equipment damage if chassis potentials are different. On two wire equipment it is a good idea to use an isolation transformer in the AC supply.
7. Never work alone. Someone trained in CPR first aid should be close enough to render aid if necessary.

V.SPECIAL SAFETY NOTES ABOUT YOUR OSCILLOSCOPE

1. Operation of this scope with the cover removed exposes voltages as high as 1500 volts. Applicable safety precautions for working around high voltages must be observed.
2. Be sure that the ground prong of the AC power cord is properly grounded. Defeating this feature by use of an improperly-connected adapter or non-grounded extension cord or other means may pose a potential shock hazard.
3. When the oscilloscope is used to measure line signals, special precautions are required. Do not connect the input lead grounding clip to either side of the line. The clip is already connected through the scope line cord to earth ground, which is common to one side of the line. It may not be readily apparent which side is common, and connecting the ground clip to the wrong side of the line will result in a "short circuit". Bear in mind that many buildings (especially residential) may not be correctly wired.

VI. PRECAUTIONS TO PROTECT YOUR OSCILLOSCOPE

The following precautions will help prevent scope damage

1. This scope is designed to be operated on nominal line voltage of 115V, 220V or 230V at 50 or 60Hz depending on how the internal circuit connections are made. Change the operating voltage see the calibration and adjustment section of this manual.
2. The internal line fuse should be 250V/0.315A (Time lag) for 115V operation and 250V/0.2A (Time lag) for 220V, 230V operation.
3. Never allow a small spot of high brilliance to remain stationary on the screen for more than a few seconds. The phosphor of the screen may become permanently damaged in that spot.
4. Do not apply excessive voltage to the scope input jacks and do not apply an external voltage to the CAL output terminal.
5. Always connect a cable from the ground terminal of the oscilloscope to the chassis of the equipment being tested. Make sure the chassis' are not at different potentials before attaching the ground.
6. Do not place objects on top of the oscilloscope or otherwise obstruct the ventilation of the case. This may cause excessive internal temperatures and premature component failure.
7. Avoid the following operating condition:
 - a. Direct sunlight
 - b. High working environment temperature and humidity.
 - c. Vibration or mechanical shock.
 - d. Operation near high-voltage, high-current electrical equipment, and strong magnetic fields.
8. Environmental conditions:

Indoor use	Relative humidity 80%(max.)
Altitude up to 2000m	Installation categories II
Ambient temperature 5°C~35°C	Pollution degree 2



CAUTION: To avoid the damage to instrument, do not apply voltages exceed 600V_{p-p}(DC+AC_{peak}) or 212VAC RMS frequency less than 1kHz.

VII. GENERAL OPERATION

1. Initial Set-Up

1. Familiarize yourself with the control locations and functions given in the panel controls and Functions section in the front of this manual.
2. To obtain a basic sweep display (numbers in parentheses indicate numbered positions on Fig. 1 and 2)
 1. Plug the AC power cord into a properly grounded outlet. See the precautions section concerning outlets.
 2. Press the POWER switch (1) to the ON position. The red LED indicator should light; if it fails to light check that there is power to the outlet you are using.
 3. Allow at least 20 seconds for warm-up of the CRT, then set the front panel control as follows:
 - INTENSITY control (2) fully clockwise
 - GND switch (15) in GND position
 - $\uparrow\downarrow$ POSITION (18) (vertical position control) in approximate center
 - $\leftarrow\rightarrow$ POSITION (4) (horizontal position control) in approximate center
 - TIME/DIV selector (7) in 1ms Position
 - TRIGGER MODE (9) in AUTO Position
 - SWP. VAR. Control (5) fully clockwise
 4. If a straight line trace is not visible, move the $\uparrow\downarrow$ POSITION (V.POSITION) control (18) clockwise or counterclockwise until it is visible.
 5. Adjust the $\leftarrow\rightarrow$ POSITION (H.POSITION) control (4) so that the sweep line starts at the left-most vertical graticule line. Use these control position whenever a basic sweep display is desired.
3. To obtain a basic signal waveform display:
 1. Set the scope control for a basic sweep display.
 2. Observe applicable precautions and connect the signal to be observed to the INPUT connector (13).
 3. Set the VOLTS/DIV selector and the VERT. VAR. control until the trace is of the desired height.
 4. Set the TIME/DIV selector and the SWP. VAR. controls until the desired portion of the waveform is display.

2. Using Different Triggering Modes

1. SOURCE of Triggering

With the SOURCE switch (10) in the INTERNAL position the triggering signal is derived from the signal being

displayed. If the SOURCE switch is in the EXTERNAL position the triggering pulse is derived from a signal input to the EXTERNAL INPUT jack (11). The triggering mode functions with SOURCE switch in EXT are the same as given above, except that triggering does not take place because of the observed waveform. The LEVEL control functions the same on an external trigger input as it does on internal.

2. LEVEL Control - See NORMAL triggering mode.

3. AUTO Triggering

In this mode the sweep is automatically internally triggered in the absence of a triggering signal. It will synchronize to a triggering signal and it may be triggered on either the positive or negative going slope of the incoming vertical signal by pushing or pulling the LEVEL control (8), however the actual LEVEL control rotation has no effect on the triggering point. The AUTO mode will function if the SOURCE is in either INTERNAL or EXTERNAL.

4. NORMAL Triggering Mode with SOURCE Switch in INT.

To use normal triggering mode, apply a vertical input signal to the INPUT connector (13). Set the scope controls for a basic signal display. Set the MODE switch to the NORM position. The voltage level of the displayed waveform that triggers the horizontal sweep is now controlled by the LEVEL control (8). If the input is a sine wave, the function of the LEVEL control is shown in Fig. 3. With the LEVEL control pushed in (column (+) in Fig. 3) the trigger will occur on the positive-going portion of the waveform. When the LEVEL control is pulled out, the trigger will occur on the negative-going slope of the waveform (column(-) in Fig. 3) When the LEVEL control is moved clockwise, the triggering point will move more positive on the waveform (line B on Fig. 3). If the LEVEL control is turned counterclockwise, the triggering point will move more negative on the waveform (line C on Fig. 3) The display must be at least one division high to obtain proper triggering. Turning the trigger LEVEL control to the extremes may cause the trigger level to be set beyond the voltages of the displayed signal. which will result in cessation of the sweep. In the normal trigger mode, the horizontal sweep will not begin without a trigger. Once the sweep is triggered, it will make one sweep at the rate set by the TIME/DIV. and the SWP.VAR control, then it will wait for the next trigger pulse.

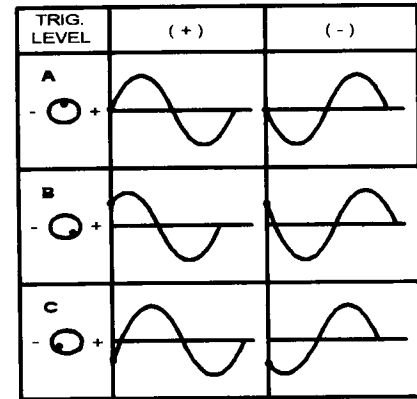

Fig. 3. Effects of triggering LEVEL control

5. TV Triggering Mode

A television video signal contains several frequencies. It may be difficult to get a stable triggered display in the NORM mode because triggering may take place on different signal components from sweep to sweep. The TV mode filters out some of the signal components to provide more stable triggering. This mode is functional on both internal and external trigger sources.

6. X-Y Position of the MODE Selector

This is not a triggering mode. When the MODE selector switch is in the X-Y position, the sweep circuits are disconnected from the horizontal amplifier and an external signal may be applied to the horizontal circuits through the EXT INPUT **(1)**. for use of this function see the procedure on relative measurements in this instruction manual.

VIII. APPLICATIONS

1. DC Voltage Measurement (Signal within one of the VOLTS/DIV ranges.)

1. Connect the signal to be measured to the vertical INPUT jack. Use the $\times 10$ probe if the voltage to be measured is higher than 40Vp-p, or refer to the section covering signals not within one of the VOLTS/DIV ranges. Be sure to observe input voltage limitations.
2. Set the scope controls to obtain a good waveform display, or, if the signal is DC, a sweep line display. Set the VOLTS/DIV Control to a value to show a measurable height of display on the screen. The VERT. VAR. control should be fully clockwise CAL position. A voltage of 15V to 40V may be displayed on the 5V/div range, 1.5V to 4V on the 0.5V/div range, 150mV to 0.4V on the 50mV range, and 15mV to 40mV on the 5mV/div range. Each of these ranges may be multiplied by 10 if a $\times 10$ probe is used. if the voltage to be measured is not within one of these ranges, refer to the section concerning signals not within one of the VOLTS/DIV ranges.
3. Place the GND switch in the GND position.
4. Adjust the V.POSITION control so that the base level line is on one of the vertical graticule divisions low enough to allow vertical display of the entire signal to be measured. Do not disturb this setting while measurement is being made.
5. Press the AC-DC Switch to the DC position and note the sweep line displacement for a DC signal (see Fig. 4) or total signal height to the level where measurement is desired.(see Fig. 5) A vertical displacement of at least 3 divisions is suggested for optimum accuracy of measurement. The reference level may be re-checked by returning the GND switch to the GND position.

6. Calculate the displayed voltage by multiplying the number of divisions of vertical displacement times the setting of the VOLTS/DIV selector times the probe attenuation factor. For example for Fig. 4 if the VOLTS/DIV selector were set to 0.5V/div and the $\times 10$ probe used, the displayed voltage would be $5 \text{ DIV} \times 0.5\text{V/div} \times 10$ (probe factor) = 25 volts

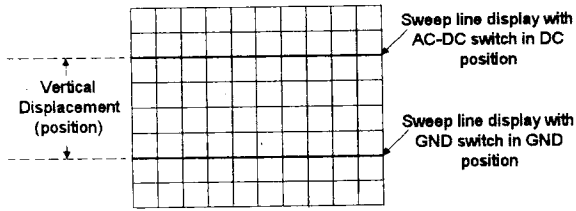

Fig.4. DC voltage measurement

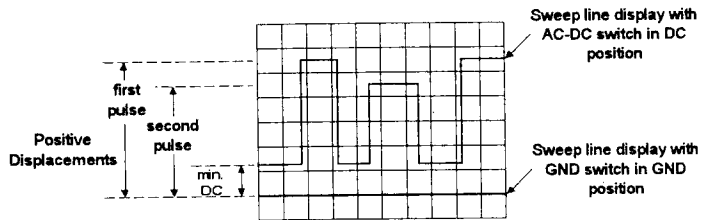

Fig.5. DC level of waveform measurement

2. Peak-to-Peak Voltage Measurements (Voltage displayable using one of the VOLTS/DIV ranges)

1. Connect the signal to be measured to the vertical INPUT jack. Be sure to observe input voltage limitations. Set up the scope to obtain a good waveform display with the AC-DC switch in the AC position. Set the VERT. VAR. control fully clockwise to the CAL position. If the waveform cannot be adequately displayed because it's too high on one VOLTS/DIV scale and too low (less than 3 divisions vertical deflection) on the next lower VOLTS/DIV ranges, then see the procedure for voltage not within one of the VOLTS/DIV ranges.
2. For optimum measurement, the portion of the waveform to be measured should be as centered as possible both horizontally and vertically.
3. Adjust the V.POSITION control until the lowest point of the waveform falls on one of the horizontal graticule lines, keeping the waveform as close to being centered as possible. (see Fig. 6)
4. Note the number of divisions of vertical displacement between the upper and lower points of the waveform where measurement is desired, and multiply this times the setting of the VOLTS/DIV selector times the probe attenuation factor. For example, in Fig. 6 if the VOLTS/DIV selector was in the 5mV/div position using the

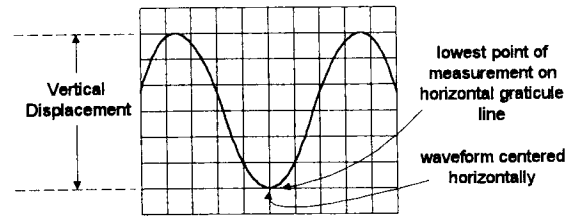

Fig.6. Peak-peak voltage measurement

$\times 1$ probe then the voltage of the waveform peak to peak would be 6 div of vertical displacement times $50\text{mV/div} \times 1(\text{probe factor}) = 300\text{mV peak-to-peak}$.

3. Peak-to-Peak Voltage Measurements (Voltage measurements when voltage being measured cannot be displayed on one of the VOLTS/DIV selector positions with the VERT. VAR. fully clockwise)

This added procedure should be used when the vertical deflection obtained from the input signal is too high for the screen on one VOLTS/DIV scale and less than 3 div high on the next lower VOLTS/DIV scale with the VERT. VAR. control in the fully clockwise CAL position.

1. Set up the scope controls for a normal sweep line display.
2. Connect the $\times 1$ input lead to the 0.25V CAL signal on the front panel.

(Another reference voltage may be used if higher accuracy is desired)

3. Set the scope controls as follows:

- SWP. VAR. to CAL
- TIME/DIV to 0.1ms
- VOLTS/DIV to 50mV
- VERT. VAR. to CAL

4. The displayed square wave should be about 5 divisions high. 5 divisions times 50mV per divisions times 1 (probe factor) is 250mV or 0.25V. This is not extremely accurate, but it should be $\pm 3\%$.
5. Adjust the VERT. VAR. control until the square wave is 2.5 division high. With the VERT. VAR. control left in this position, all of the VOLTS/DIV ranges are multiplied by 2. The 5V/div range is now 10V per division and the 0.5V/div range is now 1.0V/div etc., as long as the VERT. VAR. control is left in this newlycalibrated position. This should be accurate enough to make measurements to within $\pm 10\%$.
6. With the VERT. VAR. control left in this position, follow the procedures for AC or DC voltage measurements and multiply the VOLTS/DIV control ranges times 2.

4. Waveform Period Measurements

This procedure can be used to measure the period of a complete waveform, or the duration of any part of a waveform. The period of the waveform can then be used to calculate the frequency.

1. Connect the signal to be measure to the INPUT jack.
2. Set the scope controls to obtain a good display of the waveform with the SWP. VAR. control in the fully clockwise CAL

position. Be sure that the complete section of the waveform that you want to measure is displayed on the screen at least once. If the waveform section to be measured is too long on one TIME/DIV scale and too short (less than 3 div.) on the next higher TIME/DIV scale, see the procedure for temporarily recalibrating the sweep ranges and then return to this procedure.

3. Move the H. POSITION control until the front part of the waveform section to be measured is on a vertical graticule line. (see Fig. 7)
4. If accurate waveform frequency or period measurement is to be made, center the waveform vertically. The complete period must be measured from one point on the beginning of the waveform to the same point beginning the next waveform. (see Fig. 8)

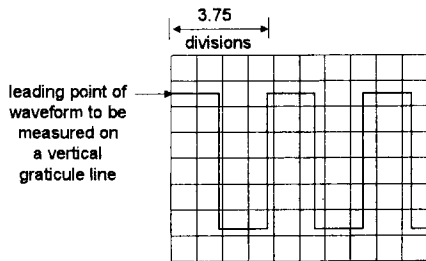

Fig. 7. Square wave period measurement

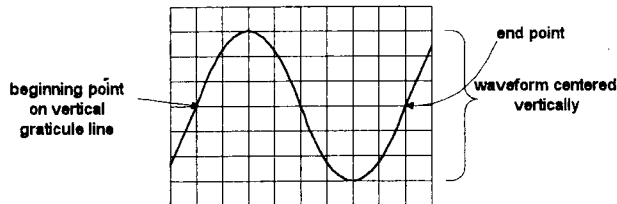

Fig. 8. Sine wave period measurement

5. Note the number of horizontal divisions of the period being measured.
6. Calculate the period by multiplying the number of horizontal divisions of the measured period times the setting of the TIME/DIV Selector. For example, the period of the pulse in Fig. 7 is 3.75 divisions. If the TIME/DIV Selector is in the 1ms/div then the period is $3.75 \text{ divisions} \times 1\text{ms/div} = 3.75\text{ms}$.
7. For frequency measurement, multiply the number of horizontal divisions covered by one complete cycle times the TIME/DIV selector setting. That gives the period of the wave. To convert to frequency, divided the period into 1.

$$\text{Frequency} = 1/\text{period}$$

For example if the TIME/DIV setting for Fig. 8 is 0.1ms/div then the period is 8 div/cycle times 0.1ms/div = 0.8 ms/cycle. The frequency is then

$$1/0.8\text{ms} = 1.25\text{kHz}$$

5. Out-of-Range Period Measurements

This procedure can be used if when the SWP.VAR. control is in the fully clockwise CAL position the waveform is longer than 10 divisions on one TIME/DIV control setting and less than 3 divisions long on the next higher TIME/DIV scale. This general procedure may also be used to compare the period of an unknown frequency to a standard.

1. Connect the vertical INPUT to the 0.25V CAL terminal using the $\times 1$ input probe. (another reference frequency may be used if desired)
2. Set up the scope controls for a normal sweep display.
3. Set scope controls as follows:
 - VOLTS/DIV to 50mV position
 - VERT.VAR. to CAL
 - TIME/DIV to 0.1ms
 - SWP.VAR. to CAL
4. The displayed square wave should now be 10 divisions long. Since the TIME/DIV control is in the 0.1ms/div position the period is $0.1\text{ms/div} \times 10 \text{ div/cycle} = 1\text{ms/cycle}$. The frequency is:

$$\text{Frequency} = 1/10 \times 0.1\text{ms} = 1\text{kHz}$$

Note that the accuracy of the CAL signal is $\pm 5\%$.

5. Move the SWP.VAR. control until the square wave is 5 divisions long. With the SWP.VAR. control in this position the time per division of each position of the TIME/DIV selector is doubled. The 10ms/div position is now 20ms/div, the 1ms/div is now 2ms/div etc. By leaving the SWP.VAR. control in this position, period and frequency measurements may be made using the procedures in this manual.

6. Phase Difference Measurement (point-shift method)

This method may be used to determine the phase difference of two sine waves.

1. Set the scope controls to obtain a normal sweep display then set the controls as follows:
 - MODE to NORM
 - SOURCE Selector to EXT
2. Connect the leading signal to both the vertical INPUT jack and the EXT INPUT jack.
3. The scope is now being triggered through the EXT INPUT. This will be the reference signal. Set the scope controls so that one or two sine waves are displayed. It may be helpful to make one cycle an exact number of divisions in length.

4. Position the sine wave so that the center of the sine wave is on the center horizontal graticule line. (see Fig. 9a)
5. Set the H.POSITION control so that the trace begins on exactly the left-most vertical graticule line.
6. Set the triggering LEVEL control so that the sine wave begins on the center horizontal graticule line. (see Fig. 9a) Make sure this control remains undisturbed for the rest of this procedure.
7. Leave the leading signal connected to the EXT INPUT (this is the reference signal the scope is triggering on) and disconnect the signal from the vertical INPUT.
8. Connect the lagging signal to the vertical INPUT jack.
9. Note the number of divisions of difference between the starting point of the reference signal displayed previously and this signal (see Fig. 9b). The phase angle difference can be calculated by first determining the period of the waveform T. Count the division covered by one complete cycle of the waveform. The phase angle can then be calculated using the following equation:

$$\text{Number of division of shift}(t) \times 360 / \text{Number of divisions of period}(T) = \text{phase shift angle or } 360t / T = \text{phase shift angle}$$

Remember that the TIME/DIV setting are multiplied by two.

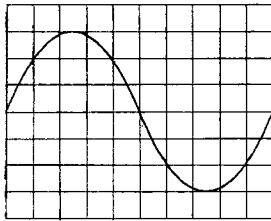

(a) Centered display

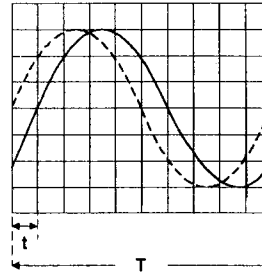

(b) Shifted display

Fig.9. Display for phase difference measurement

7. Comparative Frequency Measurements and Phase Comparisons

This method can be used to compare two frequencies if they are both sine waves and if one is adjustable in frequency or one is a harmonic of the other, and the signals are somehow synchronized This method can also be used to make a rough

phase comparison between two sinusoidal signals.

1. To make a phase or frequency comparison of two signals, connect one signal to the EXT INPUT jack. The deflection of this signal is about 0.1V per division and is not externally adjustable on the scope. Therefore, for an acceptable display the input signal must be between about 0.3V and 1V with the $\times 1$ input or 3V to 10V with the $\times 10$ probe.
2. Connect the other signal to the vertical INPUT jack .
3. Set the AC-DC switch to AC.
4. Set the MODE selector to EXT.
5. Adjust the VOLTS/DIV selector and the VERT. VAR. for a good display.

For frequency comparison the frequency ratio of vertical to horizontal will be the ratio of the number of vertical loops to the number of horizontal loops. See Fig. 10 for some examples. These patterns will vary as the phase relationship between the signal varies. (see Fig. 11, 12 and 13) If one frequency is adjustable, adjust for the desired ratio and for a stable display. For phase comparison of two signals of the same frequency see Fig. 11 and 12. These figures are for undistorted sine waves. From these figures it is not possible to determine which signal is leading or lagging. To do the phase comparison of Fig. 12, both horizontal and vertical amplitudes must be equal.

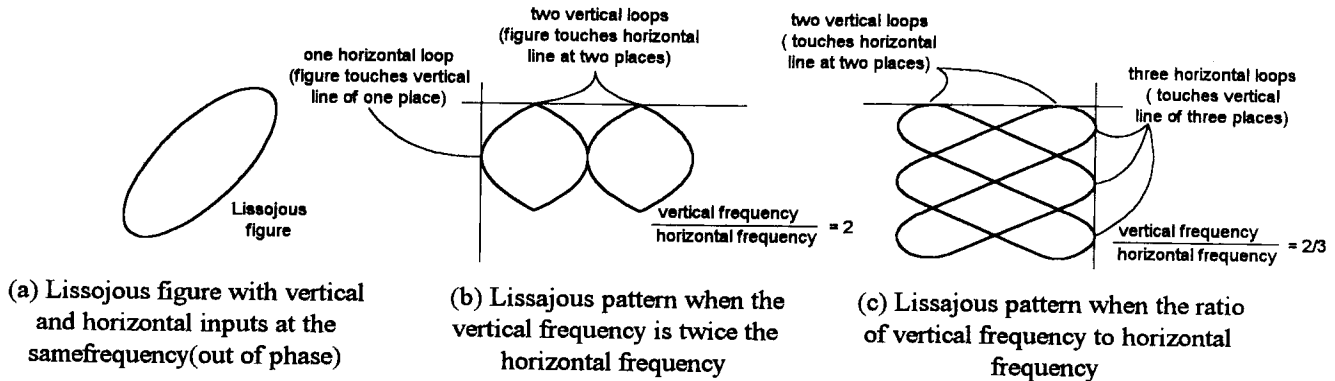

Fig.10. Lissajous patterns for frequency comparisons

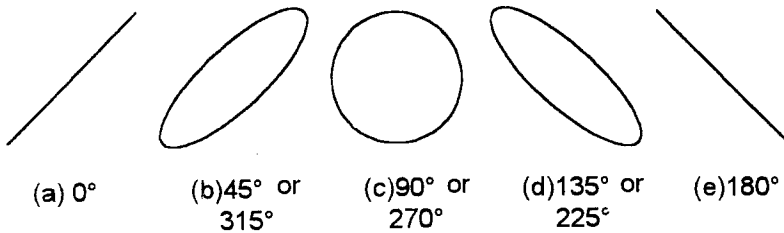

Fig. 11. Lissajous figures for phase difference between vertical and horizontal sine waves at the same frequency

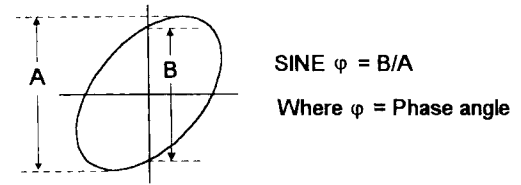

Fig. 12. Lissajous figure phase measurement

		VERTICAL ↓			
HORIZONTAL ↓	Phase shift 0° (in phase)				
	Phase shift 45°				
	Phase shift 90°				
	Frequency Ratio	$\frac{1}{1}$	$\frac{1}{2}$	$\frac{1}{3}$	$\frac{2}{3}$

Fig. 13. Lissajous figure phase and frequency comparisons

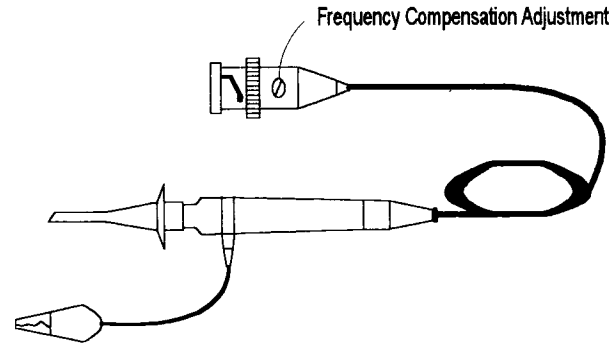
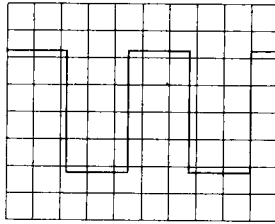

Fig. 14. Frequency compensation adjustment on the 10:1 input probe

IX. GENERAL ADJUSTMENTS AND CHECKS

1. Probe Compensation

1. Connect the 10:1 input probe to the vertical INPUT jack and to the 0.25V CAL terminal on the front of the scope.
2. Set the scope controls to obtain a good display of 2 or 3 square waves of 4 or 5 divisions amplitude.
3. Adjust the compensation trimmer on the 10:1 probe plug (Fig. 14) for flat tops on the square waves (see Fig. 15)



(a) Correct compensation

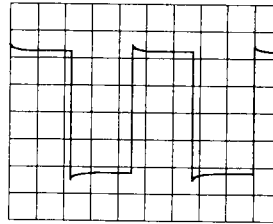

(b) Over compensation

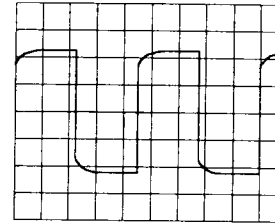

(c) Insufficient compensation

Fig. 15. Frequency compensation waveforms

2. Horizontal Trace Alignment with Graticule

If the horizontal sweep is not aligned with the horizontal graticule lines, loosen the rear CRT mounting plate screws and rotate the plate until correct alignment is obtained. (see Fig. 2)

3. Quick Calibration Check

A quick check of horizontal and vertical calibration may be done with the 0.25V CAL signal from the front panel.

This is only a rough check, however, because the CAL signal is only $\pm 3\%$ in amplitude and $\pm 5\%$ in frequency. Accurate calibration requires a more accurate signal source. To perform the quick check proceed as follows:

1. Connect the $\times 1$ input lead the vertical INPUT jack and to the 0.25V CAL signal on the front panel.
2. Set the scope controls as indicated:
 - VOLTS/DIV to 50mV
 - VERT. VAR. to CAL
 - MODE selector to AUTO

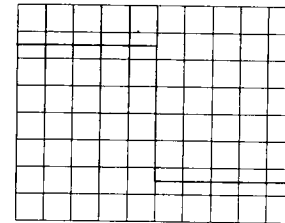

Fig. 16. Calibration

- SOURCE to INT
- TIME/DIV to 0.1ms
- SWP.VAR. to CAL

3. The displayed square wave when properly centered should be 5 divisions high and 10 divisions long.(5 division positive, 5 divisions negative) (see Fig. 16)

If the square wave is not 5 divisions high, use an accurate standard to check the vertical calibration procedure contained elsewhere in this manual. If vertical calibration is within tolerance, check the voltage output of the CAL signal and adjust it if necessary according to the procedure contained elsewhere in this manual.

If the square wave is not 10 divisions long, then check the horizontal calibration with an accurate standard and perform horizontal calibration according to the procedure contained elsewhere in this manual. If the horizontal calibration is correct, check the output frequency of the CAL signal and adjust it if necessary according to the procedure given in this manual. If the negative portion of the square wave is not the same length as the positive portion then a need for adjustment of the CAL signal is indicated.

4. Case Removal

The case should only be removed by qualified service personnel. To remove the case remove the 7 case screws, 3 on each side and 1 at the front on the top. The case may then be lifted off. Caution must also be exercised to assure that no objects strike the CRT. This may result in implosion of the CRT which could propel pieces of glass at high speeds for considerable distance with obvious safety hazards to nearby personnel.

The case must be removed to perform most of the following adjustment with the exception of fuse replacement.



WARNING: High voltages up to 1500V are present inside the scope when the unit is in operation. Line voltages are also present in certain locations even when the power switch is off. Remember also that some capacitors may hold a charge for a considerable time after the equipment is de-energized. Be sure to follow all applicable precautions contained in the safety precaution section of this manual.

5. Fuse Replacement

During normal operation of the scope the fuse should never need replacement. If the fuse is found to be open there is probably a problem with the scope. It should be checked before replacing the fuse. Replace the fuse only with a 0.315A fuse for scopes set to operate on 115V or 0.2A for scopes set to operate on 220V/230V supply. Fuse location is on the rear panel of the scope.(see Fig. 2 (21))



WARNING: To avoid personal injury disconnect the power cord before removing the fuse holder.

6. Changing Voltage of Operation

This oscilloscope is capable of being set to operate on 115VAC, 220VAC or 230VAC 50 or 60Hz supplies. To change the operating voltage, jumper wires at the small board besides the main circuit board must be moved.

For 115V operation the brown wire from the power switch should be plugged onto the pin marked 115V, as shown in Fig. 17. For 220V or 230V operation the wire from the power switch should be connected to the 220V pin for 220V operation (see Fig. 18a) or to the 230V pin for 230V operation. (see Fig. 18b)



WARNING: When change the supply line voltage, disconnect the power supply plug beforehand without fail.

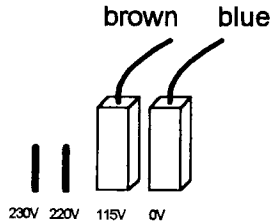
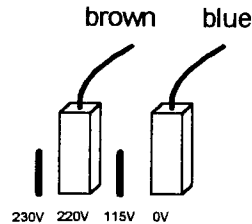
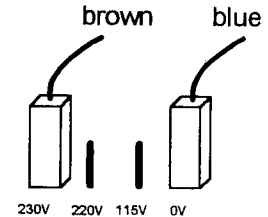

Fig.17. Connections 115V AC operation



(a) 220V operation



(b) 230V operation

Fig.18. Connections for 220V or 230V AC operation

7. Power Supply Voltage Checks

AC line 115V; 220V or 230V

DC ± 9V supply ± 10%
 ± 15V supply ± 10%
 +190V supply ± 10%

+210V supply $\pm 10\%$

-1170V supply $\pm 20\%$

8. Astigmatism Adjustment

Set the GND switch to the GND position and the MODE selector to the X-Y position. Then adjust the ASTIG pot VR103 (see Fig. 20 (D)) and the focus control for the clearest round spot.

9. Cleaning

When the outside of the case is stained, remove the stain by first wiping it lightly with a cloth moistened with neutral washing agent and then wipe the surface with a dry cloth.

When the panel surface is stained, remove the stain in similar way with a clean, soft cloth. When heavy stains are present, firsts remove the stains by wiping the surface lightly with a cloth moistened with diluted neutral washing agent and then wipe thoroughly with a dry cloth.

When dust has accumulated on the inside, remove it by using a dry brush, or by using the exhaust of a compressor or a vacuum cleaner.



WARNING: When cleaning the inside, insure beforehand that no electricity remains in the condensers of the power supply circuit.

X. VERTICAL CIRCUITS ADJUSTMENTS

1. DC Balance Adjustment

1. Set the GND switch to GND and the VOLTS/DIV selector to the 5mV/div range.
2. Adjust the DC BAL potentiometers (pots) VR201 (see Fig. 1 (14)) and VR204 (see Fig. 19 (b)) until the trace dose not shift when the VERT.VAR. control is turned.

2. High Frequency Compensation

1. Set the VOLTS/DIV selector to 5mV/div and connect a 30mV, 100kHz square wave signal of good quality with flat extremes to the INPUT jack.
2. Adjust HF COMP pot VR206 (see Fig. 19 (d)) so that the display has flat extremes as shown in Fig. 15.

3. Vertical Gain Calibration

1. Connect a 1kHz 25mVp-p square wave to the INPUT jack.
2. Set the VERT. VAR. control fully clockwise to the CAL position.
3. Set the VOLTS/DIV selector to the 5mV/div position.
4. Adjust the V.GAIN pot VR202 (see Fig. 19 (a)) so that the observed waveform is exactly 5 divisions high.

4. Vertical Position Centering

1. Turn the front panel V.POSITION control to approximate center of its travel.
2. Adjust the internal V.CENT pot VR207 (see Fig. 19 (c)) to center the trace on the screen.

5. Vertical Frequency Compensation

1. Six frequency compensation trimmers are in the scope, two for each of the vertical deflection ranges 5V/div, 0.5V/div and 50mV/div. VC201, VC202 and VC203 are for direct input compensation (1:1) and VC204, VC205 and VC206 are for compensation using the 10:1 attenuator input probe. (see Fig. 19) Optimum compensation is obtained when the VERT. VAR. control is fully clockwise in the CAL position. Since compensation of the 3 Vertical ranges is necessary, square waves of different amplitudes will be necessary. The square waves should be at a frequency of 1kHz and be of good quality with flat amplitude extremes.
2. For 1:1 compensation of the 50mV/div range connect a 1kHz square wave with an amplitude of between 0.2V and 0.4V to the vertical INPUT jack using the direct probe. Set the scope controls to display two or three cycles of the square wave. (see Fig. 15)
3. Adjust VC201 (see Fig. 19 (e)) for flat extremes on the square wave. See Fig. 15 for representative waveforms.
4. For 1:1 compensation of the 0.5V/div range connect a 1kHz square wave with an amplitude between 2V and 4V to the vertical INPUT jack using the direct probe. Set the scope controls to display two or three cycles of the square wave.
5. Adjust VC202 (Fig. 19 (f)) for flat extremes on the square wave. see Fig. 15 for representative waveforms.
6. For 1:1 compensation of the 5V/div range connect a 1kHz square wave with an amplitude between 20V and 40V to the vertical INPUT jack using the direct probe. Set the scope controls to display two or three cycles of the square wave.
7. Adjust VC203 (Fig. 19 (g)) for flat extremes on the square wave. See Fig. 15 for representative waveforms.

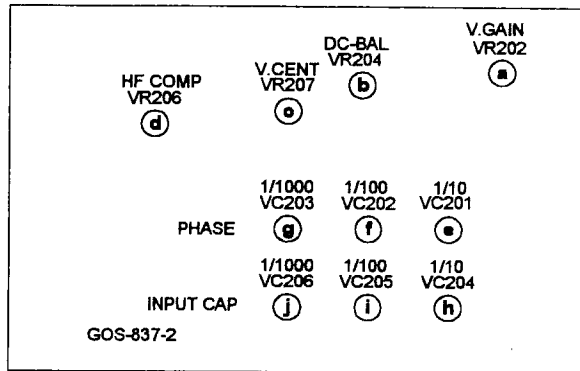

Fig. 19. Vertical circuit board. for each of the vertical deflection ranges 5V/div, 0.5V/div and 50mV/div. VC201, VC202 and VC203 are for direct input compensation (1:1) and VC204, VC205 and VC206 are for compensation using the 10:1 attenuator input probe. (see Fig. 19) Optimum compensation is obtained when the VERT. VAR. control is fully clockwise in the CAL position. Since compensation of the 3 Vertical ranges is necessary, square waves of different amplitudes will be necessary. The square waves should be at a frequency of 1kHz and be of good quality with flat amplitude extremes.

8. For 10:1 compensation use the 10:1 attenuator probe and repeat steps 2 through 7 above multiplying the required square wave input amplitude by 10 and adjusting VC204 (Fig. 19 (h)) for step 3, VC205 (Fig. 19 (I)) for step 5 and VC206 (Fig. 19 (j)) for step 7.

XI. HORIZONTAL CIRCUIT ADJUSTMENTS

1. Horizontal Variable Range Adjustment

1. Set the TIME/DIV selector to 0.1ms/div and apply a marker signal or sine wave of 1ms duration to the INPUT jack.
2. Rotate the SWP.VAR. control fully clockwise to the CAL position.
3. Adjust the SWEEP CAL pot VR307 (see Fig. 20 (E)) until one cycle of the displayed waveform is exactly 10 divisions long.
4. Turn the SWP.VAR. control fully counterclockwise.
5. Adjust the SWEEP VAR pot VR303 (see Fig. 20 (C)) until there are 12 cycles of the displayed waveform within the 10 divisions of the graticule.

2. Time Base Calibration

1. Set the TIME/DIV selector to the 1ms/div range and apply a marker signal or sine wave of 1ms duration to the INPUT jack.
2. Rotate the SWP.VAR. control fully clockwise to the CAL position.
3. Re-adjust the SWEEP CAL pot VR307 (see Fig. 20 (E)) until 10 cycles of the displayed waveform are exactly 10 divisions long.

3. Horizontal Position Adjustment

1. Connect a 1kHz sine wave to the INPUT jack.
2. Adjust the H CENT pot VR308 (see Fig. 20 (F)) so that when front panel H.POSITION control is rotated from fully clockwise to fully counterclockwise the distances A and B shown in Fig.21 are the same.

Note: This adjustment will change the external horizontal position adjustment.

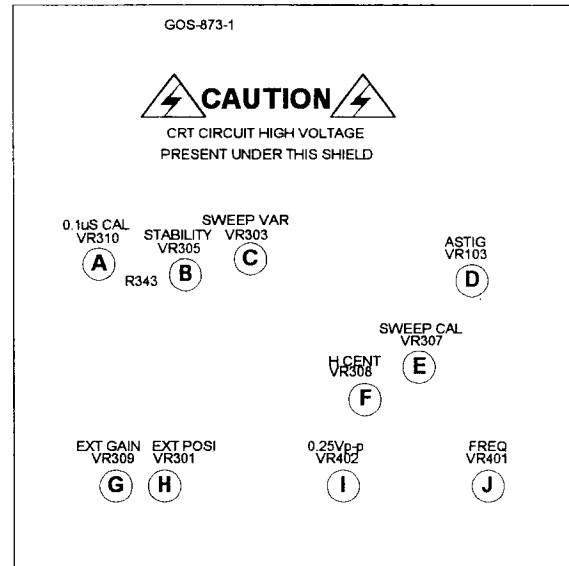
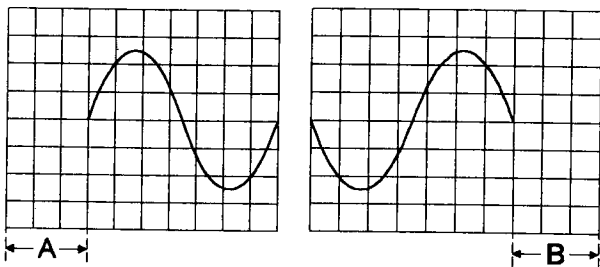
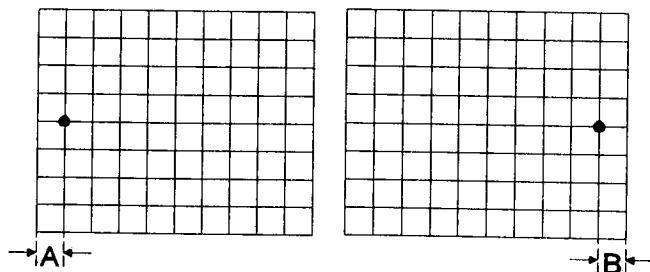

Fig.20. Main circuit board



(a) H.POSITION control rotated fully clockwise
 (b) H.POSITION control rotated fully counterclockwise

Fig. 21. Horizontal position centering



(a) H.POSITION control rotated fully clockwise
 (b) H.POSITION control rotated fully counterclockwise

Fig. 22. External horizontal position centering.

4. External Horizontal EXT Sensitivity and Position Adjustments

1. Set the GND switch to GND.
2. Set the MODE selector to X-Y, and apply a 1kHz 1Vp-p sine wave to the EXT input jack.
3. If the displayed line is longer or shorter than 10 divisions, then adjust the EXT GAIN pot VR309 (see Fig. 20 (C)) clockwise to increase the length of the display and counterclockwise to decrease its length. This adjustment will cause the display to shift right or left so adjust the EXT POSI pot VR301 (see Fig. 20 (H)) until the display line is centered again.
4. Repeat these adjustments until the display line is exactly 10 divisions long.
5. Once this adjustment is made, remove the 1kHz signal and rotate the front panel H.POSITION control clockwise and counterclockwise to see if the spot will move equal distances left and right so that distances A and B as shown in Fig. 22 are equal. If the spot does not move equal distances, adjust EXT.POSI pot VR301 until it does.

5. Triggering Stability Adjustment

1. Set the MODE selector to AUTO.
2. Set the TIME/DIV selector to the 10ms/div range.
3. Apply a 30Hz sine wave to the vertical INPUT and set the VOLTS/DIV and VERT.VAR. controls so that there is 0.5 divisions vertical height of the display.
4. Set the MODE selector to NORM.

5. Rotate the LEVEL control fully clockwise.
6. Temporarily connect a 330K resistor in parallel with R343 (see Fig. 20).
7. Adjust the STABILITY pot VR305 (see Fig. 20 (B)) clockwise until there is a signal display, then turn it counterclockwise just to the point where the sweep stops leaving a 0.5 division high vertical line.
8. Remove the 330K resistor. This should set the triggering sensitivity within the specifications given in Table 1.

INT	0.5 div on screen, 30Hz to 2 MHz
	1.5 div on screen, 2MHz to 10 MHz
EXT	0.5Vp-p, 30Hz to 2MHz
	1Vp-p, 2MHz to 10MHz

Table. 1

XII. CALIBRATE SIGNAL ADJUSTMENT

1. Calibrate Signal Frequency Adjustment

1. Set the TIME/DIV switch to the 0.1ms range.
2. Set the VOLTS/DIV switch to the 50mV/div range.
3. Set the SWP.VAR. control fully clockwise.
4. Connect the 0.25V CAL signal to the V.INPUT jack.
5. Set the SLOP switch to + (pushed in) and set the LEVEL control for a stable display.
6. Adjust the H.POSITION so that the positive portion of the square wave begins on the leftmost vertical graticule line.
7. Adjust the FREQ VR401 pot (see Fig. 20 (J)) until the positive portion of the square wave is exactly 10 divisions long.

2. Calibrate Signal Voltage Adjustment

1. Set up the scope controls like the calibrate signal frequency adjustment above.
2. Set the VERT.VAR. control fully clockwise.
3. Adjust the 0.25Vp-p VR402 (see Fig. 20 (I)) until the amplitude of the square wave is exactly 5 divisions high. The correct calibrate signal with these scope setting is shown in Fig. 16.

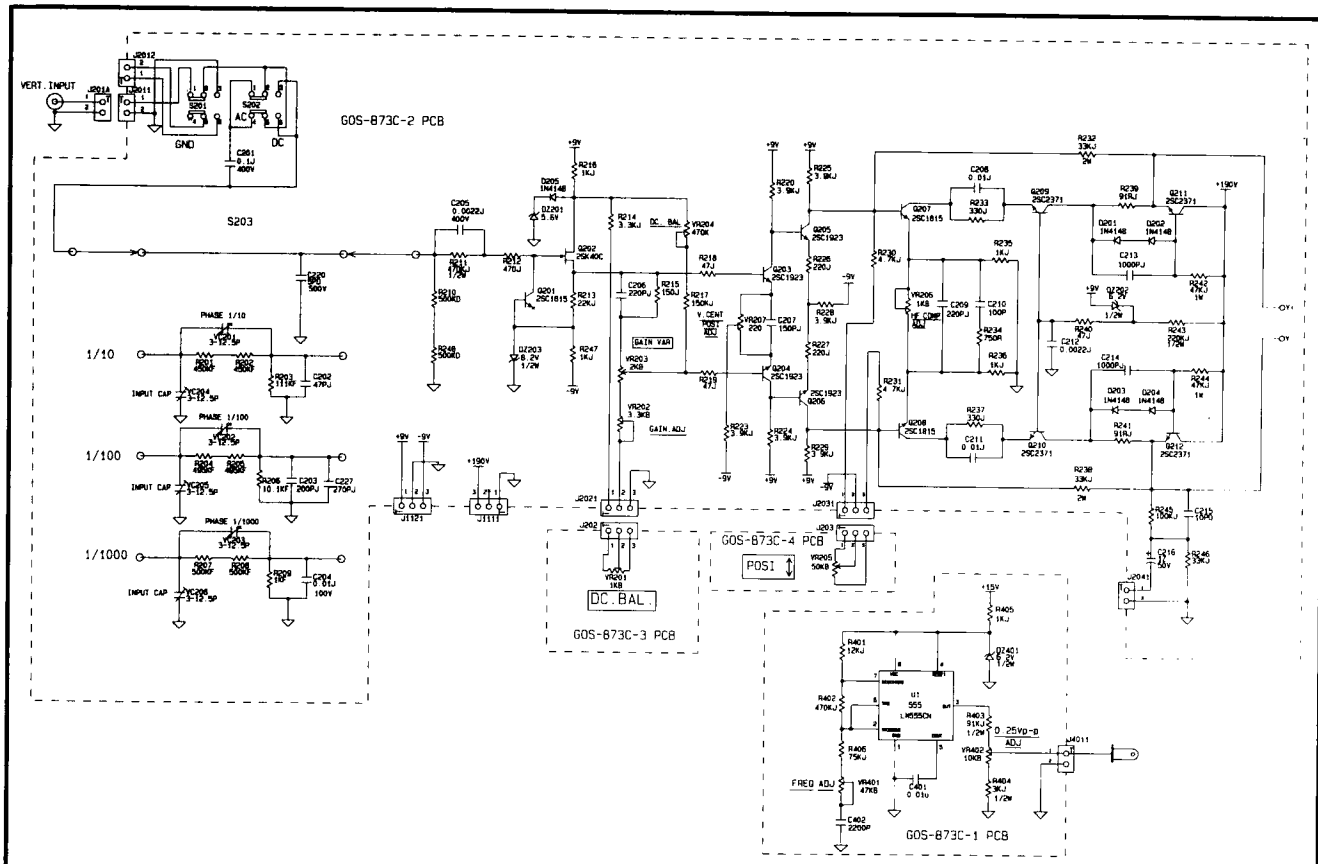

DRAWN BY	CHECKED BY	APPROVED BY	MODEL NO	GOS-310
			DESCRIPTION	Y CHANNEL
			DRAWING NO	GOS-310-3

1. Vertical Amplifier.

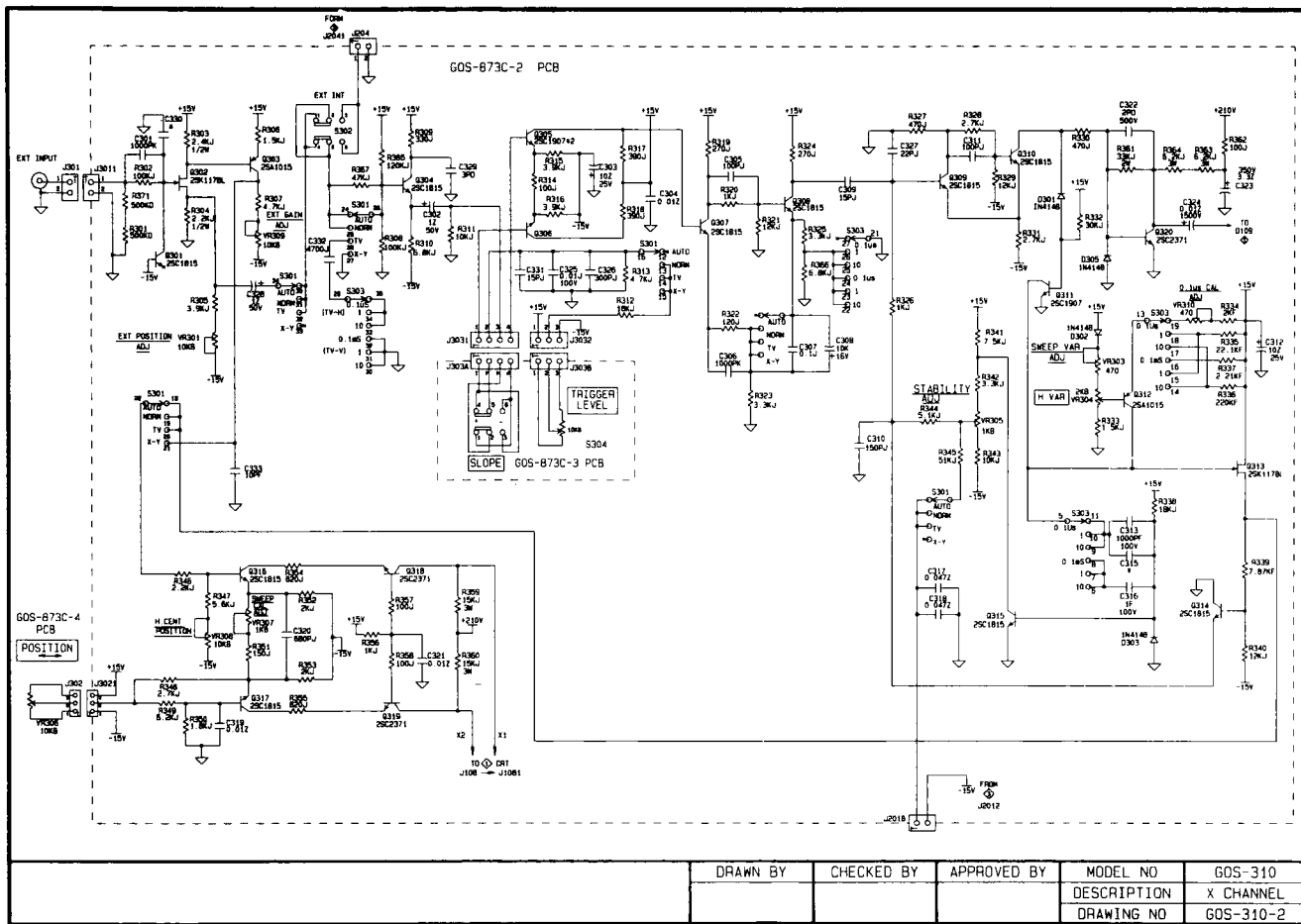

DRAWN BY	CHECKED BY	APPROVED BY	MODEL NO	GOS-310
			DESCRIPTION	X CHANNEL
			DRAWING NO	GOS-310-2

2.Horizontal Amplifier.

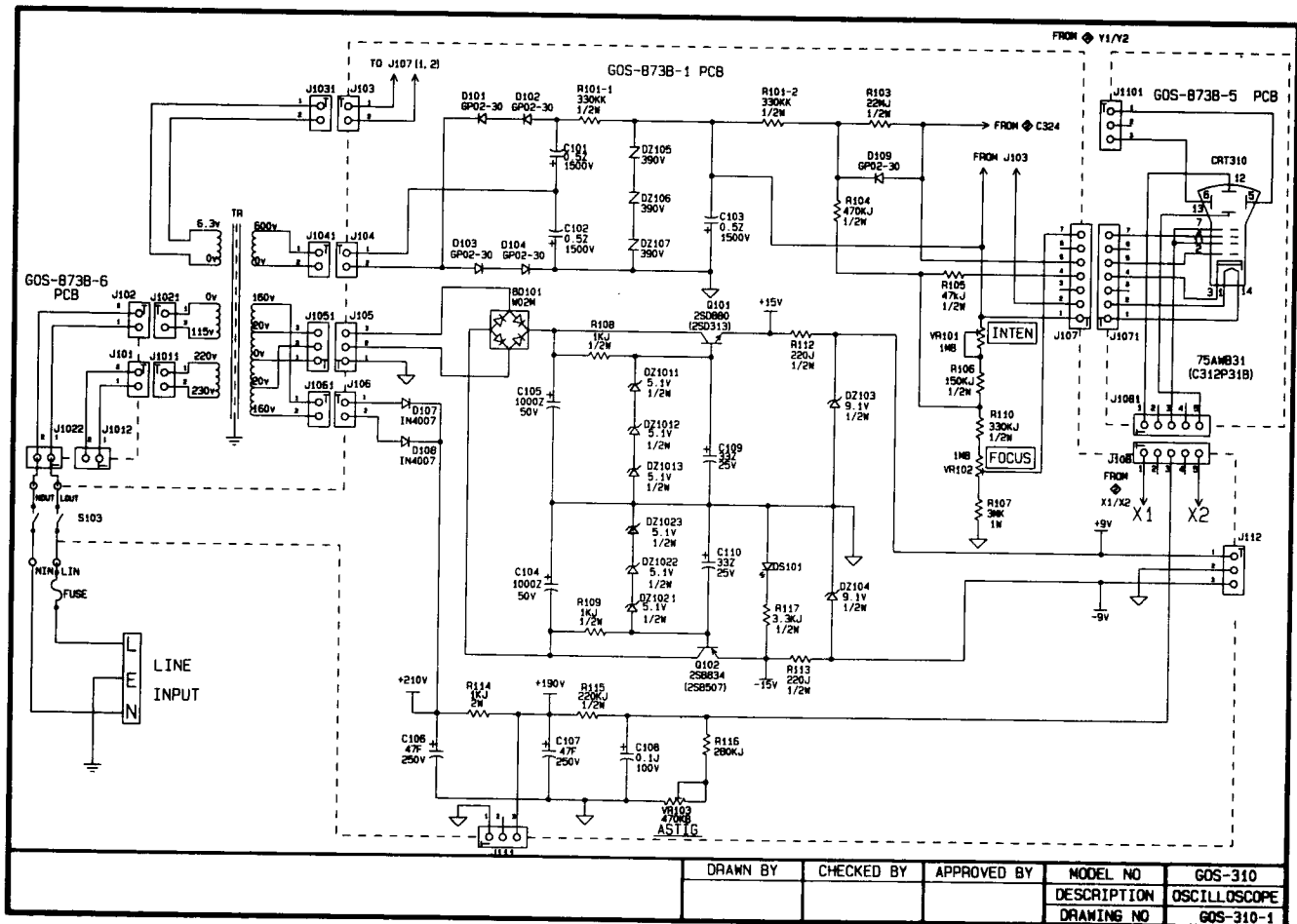

DRAWN BY	CHECKED BY	APPROVED BY	MODEL NO	GOS-310
			DESCRIPTION	OSCILLOSCOPE
			DRAWING NO	GOS-310-1

3. Power Supply.

